

# Data Sheet

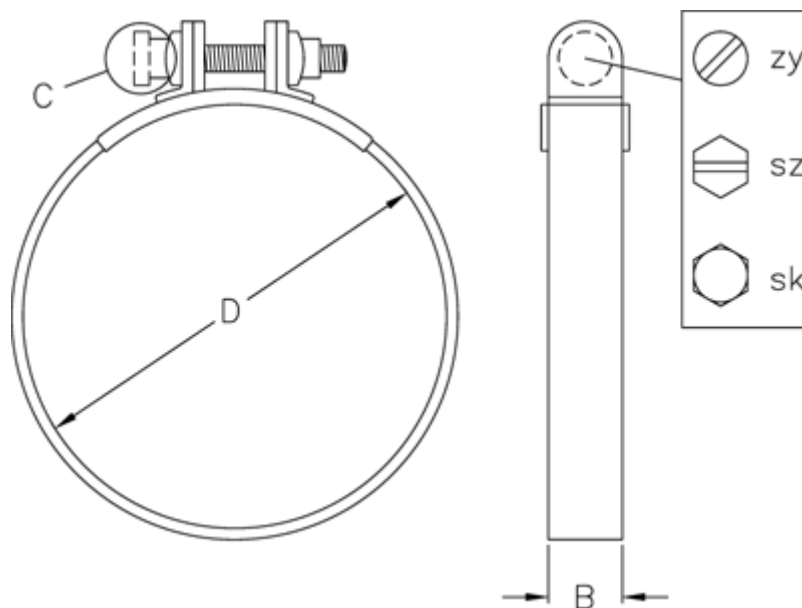

Article number: 02150000032  
Description: Sealing Clamp S 32 W1

## Measures



C (screw type) = SZ  
Diameter D = 32  
Width B = 20